

### *3.11: Deterministic Finite Automata*

In this section, we study the third of our more restricted kinds of finite automata: deterministic finite automata.

## Definition of DFAs

A *deterministic finite automaton* (DFA)  $M$  is a finite automaton such that:

- $T_M \subseteq \{q, x \rightarrow r \mid q, r \in \mathbf{Sym} \text{ and } x \in \mathbf{Str} \text{ and } |x| = 1\}$ ; and
- for all  $q \in Q_M$  and  $a \in \mathbf{alphabet } M$ , there is a unique  $r \in Q_M$  such that  $q, a \rightarrow r \in T_M$ .

## Definition of DFAs

A *deterministic finite automaton* (DFA)  $M$  is a finite automaton such that:

- $T_M \subseteq \{ q, x \rightarrow r \mid q, r \in \mathbf{Sym} \text{ and } x \in \mathbf{Str} \text{ and } |x| = 1 \}$ ; and
- for all  $q \in Q_M$  and  $a \in \mathbf{alphabet } M$ , there is a unique  $r \in Q_M$  such that  $q, a \rightarrow r \in T_M$ .

We write **DFA** for the set of all deterministic finite automata.

Thus **DFA**  $\subsetneq$  **NFA**  $\subsetneq$  **EFA**  $\subsetneq$  **FA**.

## Example DFA

Let  $M$  be the finite automaton

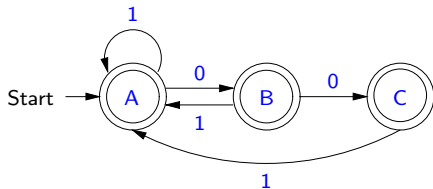

Then  $L(M) =$

## Example DFA

Let  $M$  be the finite automaton

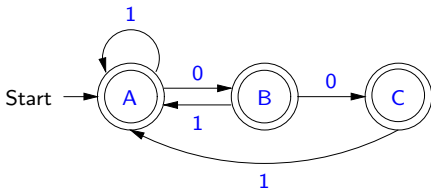

Then  $L(M) = \{ w \in \{0, 1\}^* \mid 000 \text{ is not a substring of } w \}$ .

Is  $M$  a DFA?

## Example DFA

Let  $M$  be the finite automaton

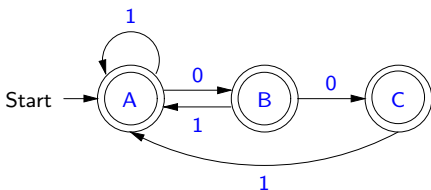

Then  $L(M) = \{ w \in \{0, 1\}^* \mid 000 \text{ is not a substring of } w \}$ .

Is  $M$  a DFA? No.  $M$  is an NFA. But  $0 \in \text{alphabet } M$  and there is no transition of the form  $C, 0 \rightarrow r$ .

## Example DFA

We can make  $M$  into a DFA by adding a dead state  $D$ :

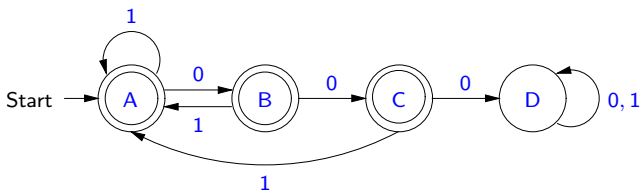

We will never need more than one dead state in a DFA.

## *Properties of DFAs*

The following proposition obviously holds.

### **Proposition 3.11.1**

Suppose  $M$  is a DFA.

- For all  $N \in \mathbf{FA}$ , if  $M$  iso  $N$ , then  $N$  is a DFA.
- For all bijections  $f$  from  $Q_M$  to some set of symbols,  $\mathbf{renameStates}(M, f)$  is a DFA.
- $\mathbf{renameStatesCanonically} M$  is a DFA.



## The $\delta$ Function

### Proposition 3.11.2

Suppose  $M$  is a DFA. For all  $q \in Q_M$  and  $w \in (\text{alphabet } M)^*$ ,  
 $|\Delta_M(\{q\}, w)| =$

**Proof.** An easy left string induction on  $w$ .  $\square$

## The $\delta$ Function

### Proposition 3.11.2

Suppose  $M$  is a DFA. For all  $q \in Q_M$  and  $w \in (\text{alphabet } M)^*$ ,  
 $|\Delta_M(\{q\}, w)| = 1$ .

**Proof.** An easy left string induction on  $w$ .  $\square$

## The $\delta$ Function

### Proposition 3.11.2

Suppose  $M$  is a DFA. For all  $q \in Q_M$  and  $w \in (\text{alphabet } M)^*$ ,  $|\Delta_M(\{q\}, w)| = 1$ .

**Proof.** An easy left string induction on  $w$ .  $\square$

Because of Proposition 3.11.2, we can define *the transition function*  $\delta_M$  for  $M$ ,  $\delta_M \in Q_M \times (\text{alphabet } M)^* \rightarrow Q_M$ , by:

$$\delta_M(q, w) = \text{the unique } r \in Q_M \text{ such that } r \in \Delta_M(\{q\}, w).$$

## The $\delta$ Function

### Proposition 3.11.2

Suppose  $M$  is a DFA. For all  $q \in Q_M$  and  $w \in (\text{alphabet } M)^*$ ,  $|\Delta_M(\{q\}, w)| = 1$ .

**Proof.** An easy left string induction on  $w$ .  $\square$

Because of Proposition 3.11.2, we can define *the transition function*  $\delta_M$  for  $M$ ,  $\delta_M \in Q_M \times (\text{alphabet } M)^* \rightarrow Q_M$ , by:

$$\delta_M(q, w) = \text{the unique } r \in Q_M \text{ such that } r \in \Delta_M(\{q\}, w).$$

Thus, for all  $q, r \in Q_M$  and  $w \in (\text{alphabet } M)^*$ ,

$$\delta_M(q, w) = r \quad \text{iff} \quad r \in \Delta_M(\{q\}, w).$$

## The $\delta$ Function

### Proposition 3.11.2

Suppose  $M$  is a DFA. For all  $q \in Q_M$  and  $w \in (\text{alphabet } M)^*$ ,  $|\Delta_M(\{q\}, w)| = 1$ .

**Proof.** An easy left string induction on  $w$ .  $\square$

Because of Proposition 3.11.2, we can define *the transition function*  $\delta_M$  for  $M$ ,  $\delta_M \in Q_M \times (\text{alphabet } M)^* \rightarrow Q_M$ , by:

$$\delta_M(q, w) = \text{the unique } r \in Q_M \text{ such that } r \in \Delta_M(\{q\}, w).$$

Thus, for all  $q, r \in Q_M$  and  $w \in (\text{alphabet } M)^*$ ,

$$\delta_M(q, w) = r \quad \text{iff} \quad r \in \Delta_M(\{q\}, w).$$

We sometimes abbreviate  $\delta_M(q, w)$  to  $\delta(q, w)$ .

## Example Uses of $\delta$

For example, if  $M$  is the DFA

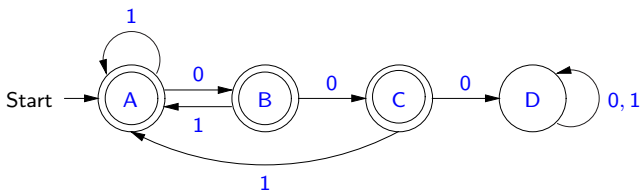

then

- $\delta(A, \%) =$
- $\delta(A, 0100) =$
- $\delta(B, 000100) =$

## Example Uses of $\delta$

For example, if  $M$  is the DFA

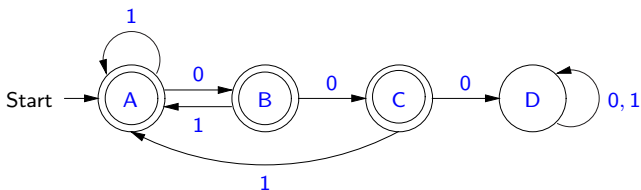

then

- $\delta(A, \%) = A$ ;
- $\delta(A, 0100) =$
- $\delta(B, 000100) =$

## Example Uses of $\delta$

For example, if  $M$  is the DFA

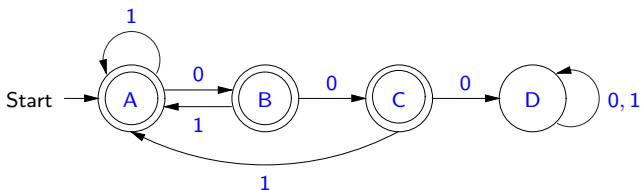

then

- $\delta(A, \%) = A$ ;
- $\delta(A, 0100) = C$ ;
- $\delta(B, 000100) =$



## Example Uses of $\delta$

For example, if  $M$  is the DFA

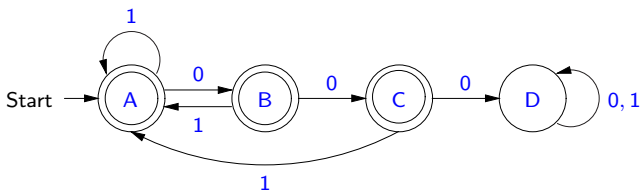

then

- $\delta(A, \%) = A$ ;
- $\delta(A, 0100) = C$ ;
- $\delta(B, 000100) = D$ .

## Properties of $\delta$

### Proposition 3.11.3

Suppose  $M$  is a DFA.

- (1) For all  $q \in Q_M$ ,  $\delta_M(q, \epsilon) =$
- (2) For all  $q \in Q_M$  and  $a \in \mathbf{alphabet\ }M$ ,  $\delta_M(q, a) =$  the unique  $r \in Q_M$  such that
- (3) For all  $q \in Q_M$  and  $x, y \in (\mathbf{alphabet\ }M)^*$ ,  
 $\delta_M(q, xy) =$

## Properties of $\delta$

### Proposition 3.11.3

Suppose  $M$  is a DFA.

- (1) For all  $q \in Q_M$ ,  $\delta_M(q, \epsilon) = q$ .
- (2) For all  $q \in Q_M$  and  $a \in \mathbf{alphabet} M$ ,  $\delta_M(q, a) =$  the unique  $r \in Q_M$  such that
- (3) For all  $q \in Q_M$  and  $x, y \in (\mathbf{alphabet} M)^*$ ,  
 $\delta_M(q, xy) =$

## Properties of $\delta$

### Proposition 3.11.3

Suppose  $M$  is a DFA.

- (1) For all  $q \in Q_M$ ,  $\delta_M(q, \epsilon) = q$ .
- (2) For all  $q \in Q_M$  and  $a \in \mathbf{alphabet\ } M$ ,  $\delta_M(q, a) =$  the unique  $r \in Q_M$  such that  $q, a \rightarrow r \in T_M$ .
- (3) For all  $q \in Q_M$  and  $x, y \in (\mathbf{alphabet\ } M)^*$ ,  
 $\delta_M(q, xy) =$

## Properties of $\delta$

### Proposition 3.11.3

Suppose  $M$  is a DFA.

- (1) For all  $q \in Q_M$ ,  $\delta_M(q, \epsilon) = q$ .
- (2) For all  $q \in Q_M$  and  $a \in \mathbf{alphabet } M$ ,  $\delta_M(q, a) =$  the unique  $r \in Q_M$  such that  $q, a \rightarrow r \in T_M$ .
- (3) For all  $q \in Q_M$  and  $x, y \in (\mathbf{alphabet } M)^*$ ,  
 $\delta_M(q, xy) = \delta_M(\delta_M(q, x), y)$ .

## Properties of $\delta$

### Proposition 3.11.3

Suppose  $M$  is a DFA.

- (1) For all  $q \in Q_M$ ,  $\delta_M(q, \epsilon) = q$ .
- (2) For all  $q \in Q_M$  and  $a \in \mathbf{alphabet} M$ ,  $\delta_M(q, a) =$  the unique  $r \in Q_M$  such that  $q, a \rightarrow r \in T_M$ .
- (3) For all  $q \in Q_M$  and  $x, y \in (\mathbf{alphabet} M)^*$ ,  
 $\delta_M(q, xy) = \delta_M(\delta_M(q, x), y)$ .

Suppose  $M$  is a DFA. By part (2) of the proposition, we have that, for all  $q, r \in Q_M$  and  $a \in \mathbf{alphabet} M$ ,

$$\delta_M(q, a) = r \quad \text{iff} \quad q, a \rightarrow r \in T_M.$$

## Checking Acceptance in DFAs

### Proposition 3.11.4

Suppose  $M$  is a DFA.

$$L(M) = \{ w \in (\text{alphabet } M)^* \mid \delta_M(s_M, w) \in A_M \}.$$

## Checking Acceptance in DFAs

### Proposition 3.11.4

Suppose  $M$  is a DFA.

$$L(M) = \{ w \in (\text{alphabet } M)^* \mid \delta_M(s_M, w) \in A_M \}.$$



## Checking Acceptance in DFAs

### Proposition 3.11.4

Suppose  $M$  is a DFA.

$$L(M) = \{ w \in (\text{alphabet } M)^* \mid \delta_M(s_M, w) \in A_M \}.$$

The preceding propositions give us an efficient algorithm for checking whether a string is accepted by a DFA. For example, suppose  $M$  is the DFA

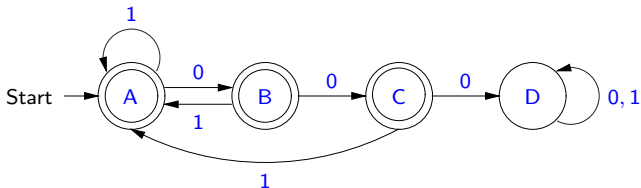

To check whether  $0100$  is accepted by  $M$ , we need to determine whether  $\delta(A, 0100) \in \{A, B, C\}$ .

## Checking Acceptance in DFAs

We have that:

$$\begin{aligned}\delta(A, 0100) &= \delta(\delta(A, 0), 100) \\ &= \\ &= \\ &= \\ &= \\ &= \\ &= \\ &\in\end{aligned}$$

Thus **0100** is accepted by *M*.

## Checking Acceptance in DFAs

We have that:

$$\begin{aligned}\delta(A, 0100) &= \delta(\delta(A, 0), 100) \\ &= \delta(B, 100) \\ &= \delta(\delta(B, 1), 00) \\ &= \\ &= \\ &= \\ &= \\ &\in\end{aligned}$$

Thus **0100** is accepted by *M*.

## Checking Acceptance in DFAs

We have that:

$$\begin{aligned}\delta(A, 0100) &= \delta(\delta(A, 0), 100) \\ &= \delta(B, 100) \\ &= \delta(\delta(B, 1), 00) \\ &= \delta(A, 00) \\ &= \delta(\delta(A, 0), 0) \\ &= \\ &= \\ &\in\end{aligned}$$

Thus **0100** is accepted by *M*.

## Checking Acceptance in DFAs

We have that:

$$\begin{aligned}\delta(A, 0100) &= \delta(\delta(A, 0), 100) \\ &= \delta(B, 100) \\ &= \delta(\delta(B, 1), 00) \\ &= \delta(A, 00) \\ &= \delta(\delta(A, 0), 0) \\ &= \delta(B, 0) \\ &= \\ &\in\end{aligned}$$

Thus **0100** is accepted by *M*.

## Checking Acceptance in DFAs

We have that:

$$\begin{aligned}\delta(A, 0100) &= \delta(\delta(A, 0), 100) \\ &= \delta(B, 100) \\ &= \delta(\delta(B, 1), 00) \\ &= \delta(A, 00) \\ &= \delta(\delta(A, 0), 0) \\ &= \delta(B, 0) \\ &= C \\ &\in \{A, B, C\}.\end{aligned}$$

Thus **0100** is accepted by *M*.

## *Proving the Correctness of DFAs*

Since every DFA is an FA, we could prove the correctness of DFAs using the techniques that we have already studied.

But it turns out that giving a separate proof that enough is accepted by a DFA is unnecessary—it will follow from the proof that everything accepted is wanted.

## Properties of $\Lambda$ and $\delta$

### Proposition 3.11.5

Suppose  $M$  is a DFA. Then, for all  $w \in (\text{alphabet } M)^*$  and  $q \in Q_M$ ,

$$w \in \Lambda_{M,q} \quad \text{iff} \quad \delta_M(s_M, w) = q.$$



## Properties of $\Lambda$ and $\delta$

### Proposition 3.11.5

Suppose  $M$  is a DFA. Then, for all  $w \in (\text{alphabet } M)^*$  and  $q \in Q_M$ ,

$$w \in \Lambda_{M,q} \quad \text{iff} \quad \delta_M(s_M, w) = q.$$

We already know that, if  $M$  is an FA, then

$$L(M) = \bigcup \{ \Lambda_q \mid q \in A_M \}.$$

## Properties of $\Lambda$ and $\delta$

### Proposition 3.11.5

Suppose  $M$  is a DFA. Then, for all  $w \in (\text{alphabet } M)^*$  and  $q \in Q_M$ ,

$$w \in \Lambda_{M,q} \quad \text{iff} \quad \delta_M(s_M, w) = q.$$

We already know that, if  $M$  is an FA, then

$$L(M) = \bigcup \{ \Lambda_q \mid q \in A_M \}.$$

### Proposition 3.11.6

Suppose  $M$  is a DFA.

$$(1) \quad (\text{alphabet } M)^* = \bigcup \{ \Lambda_q \mid q \in Q_M \}.$$

## Properties of $\Lambda$ and $\delta$

### Proposition 3.11.5

Suppose  $M$  is a DFA. Then, for all  $w \in (\text{alphabet } M)^*$  and  $q \in Q_M$ ,

$$w \in \Lambda_{M,q} \quad \text{iff} \quad \delta_M(s_M, w) = q.$$

We already know that, if  $M$  is an FA, then  $L(M) = \bigcup \{ \Lambda_q \mid q \in A_M \}$ .

### Proposition 3.11.6

Suppose  $M$  is a DFA.

- (1)  $(\text{alphabet } M)^* = \bigcup \{ \Lambda_q \mid q \in Q_M \}$ .
- (2) For all  $q, r \in Q_M$ , if  $q \neq r$ , then

## Properties of $\Lambda$ and $\delta$

### Proposition 3.11.5

Suppose  $M$  is a DFA. Then, for all  $w \in (\text{alphabet } M)^*$  and  $q \in Q_M$ ,

$$w \in \Lambda_{M,q} \quad \text{iff} \quad \delta_M(s_M, w) = q.$$

We already know that, if  $M$  is an FA, then  
 $L(M) = \bigcup \{ \Lambda_q \mid q \in A_M \}$ .

### Proposition 3.11.6

Suppose  $M$  is a DFA.

- (1)  $(\text{alphabet } M)^* = \bigcup \{ \Lambda_q \mid q \in Q_M \}$ .
- (2) For all  $q, r \in Q_M$ , if  $q \neq r$ , then  $\Lambda_q \cap \Lambda_r = \emptyset$ .

## Example DFA Correctness Proof

Suppose  $M$  is the DFA

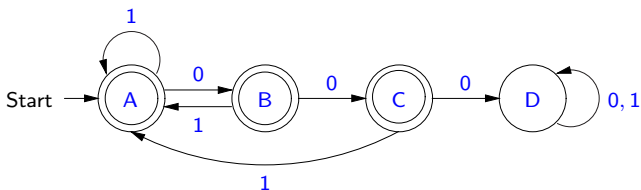

and let  $X = \{w \in \{0,1\}^* \mid 000 \text{ is not a substring of } w\}$ .

We will show that  $L(M) = X$ .

## Example DFA Correctness Proof

Suppose  $M$  is the DFA

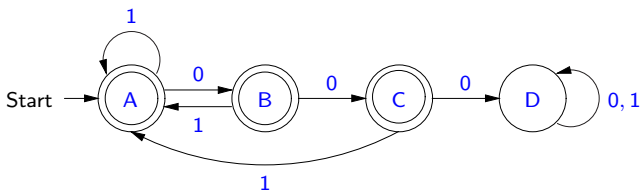

and let  $X = \{w \in \{0,1\}^* \mid 000 \text{ is not a substring of } w\}$ .

We will show that  $L(M) = X$ .

Note that, for all  $w \in \{0,1\}^*$ :

- $w \in X$  iff  $000$  is not a substring of  $w$ ; and
- $w \notin X$  iff  $000$  is a substring of  $w$ .

## *Example Correctness Proof*

First, we use induction on  $\Lambda$ , to prove that:

(A) for all  $w \in \Lambda_A$ ,

(B) for all  $w \in \Lambda_B$ ,

(C) for all  $w \in \Lambda_C$ ,

(D) for all  $w \in \Lambda_D$ ,

## *Example Correctness Proof*

First, we use induction on  $\Lambda$ , to prove that:

(A) for all  $w \in \Lambda_A$ ,  $w \in X$  and

(B) for all  $w \in \Lambda_B$ ,

(C) for all  $w \in \Lambda_C$ ,

(D) for all  $w \in \Lambda_D$ ,



## *Example Correctness Proof*

First, we use induction on  $\Lambda$ , to prove that:

- (A) for all  $w \in \Lambda_A$ ,  $w \in X$  and  $0$  is not a suffix of  $w$ ;
- (B) for all  $w \in \Lambda_B$ ,
- (C) for all  $w \in \Lambda_C$ ,
- (D) for all  $w \in \Lambda_D$ ,

## *Example Correctness Proof*

First, we use induction on  $\Lambda$ , to prove that:

- (A) for all  $w \in \Lambda_A$ ,  $w \in X$  and  $0$  is not a suffix of  $w$ ;
- (B) for all  $w \in \Lambda_B$ ,  $w \in X$  and  $0$ , but not  $00$ , is a suffix of  $w$ ;
- (C) for all  $w \in \Lambda_C$ ,
- (D) for all  $w \in \Lambda_D$ ,

## *Example Correctness Proof*

First, we use induction on  $\Lambda$ , to prove that:

- (A) for all  $w \in \Lambda_A$ ,  $w \in X$  and  $0$  is not a suffix of  $w$ ;
- (B) for all  $w \in \Lambda_B$ ,  $w \in X$  and  $0$ , but not  $00$ , is a suffix of  $w$ ;
- (C) for all  $w \in \Lambda_C$ ,  $w \in X$  and  $00$  is a suffix of  $w$ ;
- (D) for all  $w \in \Lambda_D$ ,

## *Example Correctness Proof*

First, we use induction on  $\Lambda$ , to prove that:

- (A) for all  $w \in \Lambda_A$ ,  $w \in X$  and  $0$  is not a suffix of  $w$ ;
- (B) for all  $w \in \Lambda_B$ ,  $w \in X$  and  $0$ , but not  $00$ , is a suffix of  $w$ ;
- (C) for all  $w \in \Lambda_C$ ,  $w \in X$  and  $00$  is a suffix of  $w$ ;
- (D) for all  $w \in \Lambda_D$ ,  $w \notin X$ .

## *Example Correctness Proof*

First, we use induction on  $\Lambda$ , to prove that:

- (A) for all  $w \in \Lambda_A$ ,  $w \in X$  and  $0$  is not a suffix of  $w$ ;
- (B) for all  $w \in \Lambda_B$ ,  $w \in X$  and  $0$ , but not  $00$ , is a suffix of  $w$ ;
- (C) for all  $w \in \Lambda_C$ ,  $w \in X$  and  $00$  is a suffix of  $w$ ;
- (D) for all  $w \in \Lambda_D$ ,  $w \notin X$ .

There are nine steps ( $1 +$  the number of transitions) to show.

- **(empty string)** We must show that

## Example Correctness Proof

First, we use induction on  $\Lambda$ , to prove that:

- (A) for all  $w \in \Lambda_A$ ,  $w \in X$  and  $0$  is not a suffix of  $w$ ;
- (B) for all  $w \in \Lambda_B$ ,  $w \in X$  and  $0$ , but not  $00$ , is a suffix of  $w$ ;
- (C) for all  $w \in \Lambda_C$ ,  $w \in X$  and  $00$  is a suffix of  $w$ ;
- (D) for all  $w \in \Lambda_D$ ,  $w \notin X$ .

There are nine steps ( $1 +$  the number of transitions) to show.

- **(empty string)** We must show that  $\% \in X$  and  $0$  is not a suffix of  $\%$ . This follows since  $\%$  has no  $0$ 's.

## Example Correctness Proof

First, we use induction on  $\Lambda$ , to prove that:

- (A) for all  $w \in \Lambda_A$ ,  $w \in X$  and  $0$  is not a suffix of  $w$ ;
- (B) for all  $w \in \Lambda_B$ ,  $w \in X$  and  $0$ , but not  $00$ , is a suffix of  $w$ ;
- (C) for all  $w \in \Lambda_C$ ,  $w \in X$  and  $00$  is a suffix of  $w$ ;
- (D) for all  $w \in \Lambda_D$ ,  $w \notin X$ .

There are nine steps ( $1 +$  the number of transitions) to show.

- **(empty string)** We must show that  $\% \in X$  and  $0$  is not a suffix of  $\%$ . This follows since  $\%$  has no  $0$ 's.
- **(A,  $0 \rightarrow B$ )** Suppose  $w \in \Lambda_A$ , and assume the inductive hypothesis:

## Example Correctness Proof

First, we use induction on  $\Lambda$ , to prove that:

- (A) for all  $w \in \Lambda_A$ ,  $w \in X$  and 0 is not a suffix of  $w$ ;
- (B) for all  $w \in \Lambda_B$ ,  $w \in X$  and 0, but not 00, is a suffix of  $w$ ;
- (C) for all  $w \in \Lambda_C$ ,  $w \in X$  and 00 is a suffix of  $w$ ;
- (D) for all  $w \in \Lambda_D$ ,  $w \notin X$ .

There are nine steps (1 + the number of transitions) to show.

- **(empty string)** We must show that  $\% \in X$  and 0 is not a suffix of  $\%$ . This follows since  $\%$  has no 0's.
- **(A, 0  $\rightarrow$  B)** Suppose  $w \in \Lambda_A$ , and assume the inductive hypothesis:  $w \in X$  and 0 is not a suffix of  $w$ . We must show that



## Example Correctness Proof

First, we use induction on  $\Lambda$ , to prove that:

- (A) for all  $w \in \Lambda_A$ ,  $w \in X$  and  $0$  is not a suffix of  $w$ ;
- (B) for all  $w \in \Lambda_B$ ,  $w \in X$  and  $0$ , but not  $00$ , is a suffix of  $w$ ;
- (C) for all  $w \in \Lambda_C$ ,  $w \in X$  and  $00$  is a suffix of  $w$ ;
- (D) for all  $w \in \Lambda_D$ ,  $w \notin X$ .

There are nine steps ( $1 +$  the number of transitions) to show.

- **(empty string)** We must show that  $\% \in X$  and  $0$  is not a suffix of  $\%$ . This follows since  $\%$  has no  $0$ 's.
- **(A,  $0 \rightarrow B$ )** Suppose  $w \in \Lambda_A$ , and assume the inductive hypothesis:  $w \in X$  and  $0$  is not a suffix of  $w$ . We must show that  $w0 \in X$  and  $0$ , but not  $00$ , is a suffix of  $w0$ .

## Example Correctness Proof

First, we use induction on  $\Lambda$ , to prove that:

- (A) for all  $w \in \Lambda_A$ ,  $w \in X$  and  $0$  is not a suffix of  $w$ ;
- (B) for all  $w \in \Lambda_B$ ,  $w \in X$  and  $0$ , but not  $00$ , is a suffix of  $w$ ;
- (C) for all  $w \in \Lambda_C$ ,  $w \in X$  and  $00$  is a suffix of  $w$ ;
- (D) for all  $w \in \Lambda_D$ ,  $w \notin X$ .

There are nine steps ( $1 +$  the number of transitions) to show.

- **(empty string)** We must show that  $\% \in X$  and  $0$  is not a suffix of  $\%$ . This follows since  $\%$  has no  $0$ 's.
- **(A,  $0 \rightarrow B$ )** Suppose  $w \in \Lambda_A$ , and assume the inductive hypothesis:  $w \in X$  and  $0$  is not a suffix of  $w$ . We must show that  $w0 \in X$  and  $0$ , but not  $00$ , is a suffix of  $w0$ . Because  $w \in X$  and  $0$  is not a suffix of  $w$ , we have that  $w0 \in X$ . Clearly,  $0$  is a suffix of  $w0$ . And, since  $0$  is not a suffix of  $w$ , we have that  $00$  is not a suffix of  $w0$ .

## *Example Correctness Proof*

- $(A, 1 \rightarrow A)$  Suppose  $w \in \Lambda_A$ , and assume the inductive hypothesis:

## *Example Correctness Proof*

- **(A, 1  $\rightarrow$  A)** Suppose  $w \in \Lambda_A$ , and assume the inductive hypothesis:  $w \in X$  and 0 is not a suffix of  $w$ . We must show that

## *Example Correctness Proof*

- **(A, 1  $\rightarrow$  A)** Suppose  $w \in \Lambda_A$ , and assume the inductive hypothesis:  $w \in X$  and 0 is not a suffix of  $w$ . We must show that  $w1 \in X$  and 0 is not a suffix of  $w1$ .

## *Example Correctness Proof*

- **(A, 1  $\rightarrow$  A)** Suppose  $w \in \Lambda_A$ , and assume the inductive hypothesis:  $w \in X$  and 0 is not a suffix of  $w$ . We must show that  $w1 \in X$  and 0 is not a suffix of  $w1$ . Since  $w \in X$ , we have that  $w1 \in X$ . And, 0 is not a suffix of  $w1$ .

## *Example Correctness Proof*

- **(A, 1  $\rightarrow$  A)** Suppose  $w \in \Lambda_A$ , and assume the inductive hypothesis:  $w \in X$  and 0 is not a suffix of  $w$ . We must show that  $w1 \in X$  and 0 is not a suffix of  $w1$ . Since  $w \in X$ , we have that  $w1 \in X$ . And, 0 is not a suffix of  $w1$ .
- **(B, 0  $\rightarrow$  C)** Suppose  $w \in \Lambda_B$ , and assume the inductive hypothesis:  $w \in X$  and 0, but not 00, is a suffix of  $w$ . We must show that  $w0 \in X$  and 00 is a suffix of  $w0$ .

## *Example Correctness Proof*

- **(A, 1  $\rightarrow$  A)** Suppose  $w \in \Lambda_A$ , and assume the inductive hypothesis:  $w \in X$  and 0 is not a suffix of  $w$ . We must show that  $w1 \in X$  and 0 is not a suffix of  $w1$ . Since  $w \in X$ , we have that  $w1 \in X$ . And, 0 is not a suffix of  $w1$ .
- **(B, 0  $\rightarrow$  C)** Suppose  $w \in \Lambda_B$ , and assume the inductive hypothesis:  $w \in X$  and 0, but not 00, is a suffix of  $w$ . We must show that  $w0 \in X$  and 00 is a suffix of  $w0$ . Because  $w \in X$  and 00 is not suffix of  $w$ , we have that  $w0 \in X$ . And since 0 is a suffix of  $w$ , it follows that 00 is a suffix of  $w0$ .



## *Example Correctness Proof*

- **(A,  $1 \rightarrow A$ )** Suppose  $w \in \Lambda_A$ , and assume the inductive hypothesis:  $w \in X$  and  $0$  is not a suffix of  $w$ . We must show that  $w1 \in X$  and  $0$  is not a suffix of  $w1$ . Since  $w \in X$ , we have that  $w1 \in X$ . And,  $0$  is not a suffix of  $w1$ .
- **(B,  $0 \rightarrow C$ )** Suppose  $w \in \Lambda_B$ , and assume the inductive hypothesis:  $w \in X$  and  $0$ , but not  $00$ , is a suffix of  $w$ . We must show that  $w0 \in X$  and  $00$  is a suffix of  $w0$ . Because  $w \in X$  and  $00$  is not suffix of  $w$ , we have that  $w0 \in X$ . And since  $0$  is a suffix of  $w$ , it follows that  $00$  is a suffix of  $w0$ .
- **(B,  $1 \rightarrow A$ )** Suppose  $w \in \Lambda_B$ , and assume the inductive hypothesis:  $w \in X$  and  $0$ , but not  $00$ , is a suffix of  $w$ . We must show that  $w1 \in X$  and  $0$  is not a suffix of  $w1$ .

## *Example Correctness Proof*

- **(A, 1  $\rightarrow$  A)** Suppose  $w \in \Lambda_A$ , and assume the inductive hypothesis:  $w \in X$  and 0 is not a suffix of  $w$ . We must show that  $w1 \in X$  and 0 is not a suffix of  $w1$ . Since  $w \in X$ , we have that  $w1 \in X$ . And, 0 is not a suffix of  $w1$ .
- **(B, 0  $\rightarrow$  C)** Suppose  $w \in \Lambda_B$ , and assume the inductive hypothesis:  $w \in X$  and 0, but not 00, is a suffix of  $w$ . We must show that  $w0 \in X$  and 00 is a suffix of  $w0$ . Because  $w \in X$  and 00 is not suffix of  $w$ , we have that  $w0 \in X$ . And since 0 is a suffix of  $w$ , it follows that 00 is a suffix of  $w0$ .
- **(B, 1  $\rightarrow$  A)** Suppose  $w \in \Lambda_B$ , and assume the inductive hypothesis:  $w \in X$  and 0, but not 00, is a suffix of  $w$ . We must show that  $w1 \in X$  and 0 is not a suffix of  $w1$ . Because  $w \in X$ , we have that  $w1 \in X$ . And, 0 is not a suffix of  $w1$ .

## *Example Correctness Proof*

- **(C,  $0 \rightarrow D$ )** Suppose  $w \in \Lambda_C$ , and assume the inductive hypothesis:  $w \in X$  and  $00$  is a suffix of  $w$ . We must show that  $w0 \notin X$ .

## *Example Correctness Proof*

- **(C, 0  $\rightarrow$  D)** Suppose  $w \in \Lambda_C$ , and assume the inductive hypothesis:  $w \in X$  and  $00$  is a suffix of  $w$ . We must show that  $w0 \notin X$ . Because  $00$  is a suffix of  $w$ , we have that  $000$  is a suffix of  $w0$ . Thus  $w0 \notin X$ .

## *Example Correctness Proof*

- **(C, 0  $\rightarrow$  D)** Suppose  $w \in \Lambda_C$ , and assume the inductive hypothesis:  $w \in X$  and  $00$  is a suffix of  $w$ . We must show that  $w0 \notin X$ . Because  $00$  is a suffix of  $w$ , we have that  $000$  is a suffix of  $w0$ . Thus  $w0 \notin X$ .
- **(C, 1  $\rightarrow$  A)** Suppose  $w \in \Lambda_C$ , and assume the inductive hypothesis:  $w \in X$  and  $00$  is a suffix of  $w$ . We must show that  $w1 \in X$  and  $0$  is not a suffix of  $w1$ .

## *Example Correctness Proof*

- **(C, 0  $\rightarrow$  D)** Suppose  $w \in \Lambda_C$ , and assume the inductive hypothesis:  $w \in X$  and  $00$  is a suffix of  $w$ . We must show that  $w0 \notin X$ . Because  $00$  is a suffix of  $w$ , we have that  $000$  is a suffix of  $w0$ . Thus  $w0 \notin X$ .
- **(C, 1  $\rightarrow$  A)** Suppose  $w \in \Lambda_C$ , and assume the inductive hypothesis:  $w \in X$  and  $00$  is a suffix of  $w$ . We must show that  $w1 \in X$  and  $0$  is not a suffix of  $w1$ . Because  $w \in X$ , we have that  $w1 \in X$ . And,  $0$  is not a suffix of  $w1$ .

## Example Correctness Proof

- **(C, 0  $\rightarrow$  D)** Suppose  $w \in \Lambda_C$ , and assume the inductive hypothesis:  $w \in X$  and  $00$  is a suffix of  $w$ . We must show that  $w0 \notin X$ . Because  $00$  is a suffix of  $w$ , we have that  $000$  is a suffix of  $w0$ . Thus  $w0 \notin X$ .
- **(C, 1  $\rightarrow$  A)** Suppose  $w \in \Lambda_C$ , and assume the inductive hypothesis:  $w \in X$  and  $00$  is a suffix of  $w$ . We must show that  $w1 \in X$  and  $0$  is not a suffix of  $w1$ . Because  $w \in X$ , we have that  $w1 \in X$ . And,  $0$  is not a suffix of  $w1$ .
- **(D, 0  $\rightarrow$  D)** Suppose  $w \in \Lambda_D$ , and assume the inductive hypothesis:  $w \notin X$ . We must show that  $w0 \notin X$ .

## Example Correctness Proof

- **(C, 0  $\rightarrow$  D)** Suppose  $w \in \Lambda_C$ , and assume the inductive hypothesis:  $w \in X$  and  $00$  is a suffix of  $w$ . We must show that  $w0 \notin X$ . Because  $00$  is a suffix of  $w$ , we have that  $000$  is a suffix of  $w0$ . Thus  $w0 \notin X$ .
- **(C, 1  $\rightarrow$  A)** Suppose  $w \in \Lambda_C$ , and assume the inductive hypothesis:  $w \in X$  and  $00$  is a suffix of  $w$ . We must show that  $w1 \in X$  and  $0$  is not a suffix of  $w1$ . Because  $w \in X$ , we have that  $w1 \in X$ . And,  $0$  is not a suffix of  $w1$ .
- **(D, 0  $\rightarrow$  D)** Suppose  $w \in \Lambda_D$ , and assume the inductive hypothesis:  $w \notin X$ . We must show that  $w0 \notin X$ . Because  $w \notin X$ , we have that  $w0 \notin X$ .



## Example Correctness Proof

- **(C, 0  $\rightarrow$  D)** Suppose  $w \in \Lambda_C$ , and assume the inductive hypothesis:  $w \in X$  and  $00$  is a suffix of  $w$ . We must show that  $w0 \notin X$ . Because  $00$  is a suffix of  $w$ , we have that  $000$  is a suffix of  $w0$ . Thus  $w0 \notin X$ .
- **(C, 1  $\rightarrow$  A)** Suppose  $w \in \Lambda_C$ , and assume the inductive hypothesis:  $w \in X$  and  $00$  is a suffix of  $w$ . We must show that  $w1 \in X$  and  $0$  is not a suffix of  $w1$ . Because  $w \in X$ , we have that  $w1 \in X$ . And,  $0$  is not a suffix of  $w1$ .
- **(D, 0  $\rightarrow$  D)** Suppose  $w \in \Lambda_D$ , and assume the inductive hypothesis:  $w \notin X$ . We must show that  $w0 \notin X$ . Because  $w \notin X$ , we have that  $w0 \notin X$ .
- **(D, 1  $\rightarrow$  D)** Suppose  $w \in \Lambda_D$ , and assume the inductive hypothesis:  $w \notin X$ . We must show that  $w1 \notin X$ .

## Example Correctness Proof

- **(C, 0  $\rightarrow$  D)** Suppose  $w \in \Lambda_C$ , and assume the inductive hypothesis:  $w \in X$  and  $00$  is a suffix of  $w$ . We must show that  $w0 \notin X$ . Because  $00$  is a suffix of  $w$ , we have that  $000$  is a suffix of  $w0$ . Thus  $w0 \notin X$ .
- **(C, 1  $\rightarrow$  A)** Suppose  $w \in \Lambda_C$ , and assume the inductive hypothesis:  $w \in X$  and  $00$  is a suffix of  $w$ . We must show that  $w1 \in X$  and  $0$  is not a suffix of  $w1$ . Because  $w \in X$ , we have that  $w1 \in X$ . And,  $0$  is not a suffix of  $w1$ .
- **(D, 0  $\rightarrow$  D)** Suppose  $w \in \Lambda_D$ , and assume the inductive hypothesis:  $w \notin X$ . We must show that  $w0 \notin X$ . Because  $w \notin X$ , we have that  $w0 \notin X$ .
- **(D, 1  $\rightarrow$  D)** Suppose  $w \in \Lambda_D$ , and assume the inductive hypothesis:  $w \notin X$ . We must show that  $w1 \notin X$ . Because  $w \notin X$ , we have that  $w1 \notin X$ .

## *Example Correctness Proof*

Now, we use the result of our induction on  $\wedge$  to show that  $L(M) = X$ .

- $(L(M) \subseteq X)$
  
- $(X \subseteq L(M))$

## *Example Correctness Proof*

Now, we use the result of our induction on  $\Lambda$  to show that  $L(M) = X$ .

- $(L(M) \subseteq X)$  Suppose  $w \in L(M)$ . Because  $A_M = \{A, B, C\}$ , we have that  $w \in L(M) = \Lambda_A \cup \Lambda_B \cup \Lambda_C$ . Thus, by parts (A)–(C), we have that  $w \in X$ .
- $(X \subseteq L(M))$

## Example Correctness Proof

Now, we use the result of our induction on  $\Lambda$  to show that  $L(M) = X$ .

- $(L(M) \subseteq X)$  Suppose  $w \in L(M)$ . Because  $A_M = \{A, B, C\}$ , we have that  $w \in L(M) = \Lambda_A \cup \Lambda_B \cup \Lambda_C$ . Thus, by parts (A)–(C), we have that  $w \in X$ .
- $(X \subseteq L(M))$  Suppose  $w \in X$ . Since  $X \subseteq \{0, 1\}^*$ , we have that  $w \in \{0, 1\}^*$ .

## Example Correctness Proof

Now, we use the result of our induction on  $\Lambda$  to show that  $L(M) = X$ .

- $(L(M) \subseteq X)$  Suppose  $w \in L(M)$ . Because  $A_M = \{A, B, C\}$ , we have that  $w \in L(M) = \Lambda_A \cup \Lambda_B \cup \Lambda_C$ . Thus, by parts (A)–(C), we have that  $w \in X$ .
- $(X \subseteq L(M))$  Suppose  $w \in X$ . Since  $X \subseteq \{0, 1\}^*$ , we have that  $w \in \{0, 1\}^*$ . Suppose, toward a contradiction, that  $w \notin L(M)$ . Because  $w \notin L(M) = \Lambda_A \cup \Lambda_B \cup \Lambda_C$  and  $w \in \{0, 1\}^* = (\mathbf{alphabet\ } M)^* = \Lambda_A \cup \Lambda_B \cup \Lambda_C \cup \Lambda_D$ , we must have that

## Example Correctness Proof

Now, we use the result of our induction on  $\Lambda$  to show that  $L(M) = X$ .

- $(L(M) \subseteq X)$  Suppose  $w \in L(M)$ . Because  $A_M = \{A, B, C\}$ , we have that  $w \in L(M) = \Lambda_A \cup \Lambda_B \cup \Lambda_C$ . Thus, by parts (A)–(C), we have that  $w \in X$ .
- $(X \subseteq L(M))$  Suppose  $w \in X$ . Since  $X \subseteq \{0, 1\}^*$ , we have that  $w \in \{0, 1\}^*$ . Suppose, toward a contradiction, that  $w \notin L(M)$ . Because  $w \notin L(M) = \Lambda_A \cup \Lambda_B \cup \Lambda_C$  and  $w \in \{0, 1\}^* = (\mathbf{alphabet\ } M)^* = \Lambda_A \cup \Lambda_B \cup \Lambda_C \cup \Lambda_D$ , we must have that  $w \in \Lambda_D$ . But then part (D) tells us that  $w \notin X$ —contradiction. Thus  $w \in L(M)$ .

## *Simplification of DFAs*

Let  $M$  be our example DFA

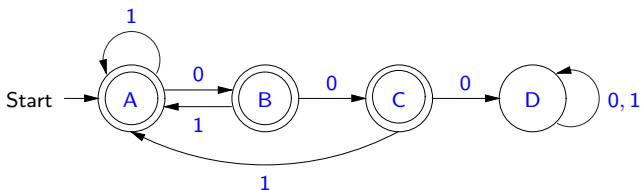

Is  $M$  simplified?



## Simplification of DFAs

Let  $M$  be our example DFA

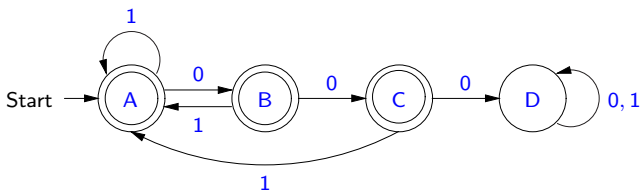

Is  $M$  simplified? No, since the state  $D$  is dead. But if we get rid of  $D$ , then we won't have a DFA anymore.

Thus, we will need:

- a notion of when a DFA is simplified that is more liberal than our standard notion;
- a corresponding simplification procedure for DFAs.

## *Definition of Deterministically Simplified*

We say that a DFA  $M$  is *deterministically simplified* iff

- every element of  $Q_M$  is reachable; and
- at most one element of  $Q_M$  is dead.

## Definition of Deterministically Simplified

We say that a DFA  $M$  is *deterministically simplified* iff

- every element of  $Q_M$  is reachable; and
- at most one element of  $Q_M$  is dead.

For example, the following DFAs, which both accept  $\emptyset$ , are both deterministically simplified:

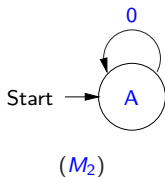
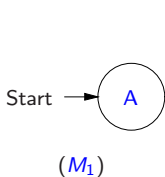

## *A Simplification Algorithm for DFAs*

We define a simplification algorithm for DFAs that takes in

- a DFA  $M$  and
- an alphabet  $\Sigma$

and returns a DFA  $N$  such that

- $N$  is deterministically simplified,
- $N \approx M$ , and
- **alphabet**  $N = \mathbf{alphabet}(L(M)) \cup \Sigma$ .

## *A Simplification Algorithm*

The algorithm begins by letting the FA  $M'$  be **simplify**  $M$ , i.e., the result of running our simplification algorithm for FAs on  $M$ .  $M'$  will have the following properties:

- $M'$  is simplified.
- $M' \approx M$ .
- **alphabet**  $M' = \mathbf{alphabet}(L(M')) = \mathbf{alphabet}(L(M))$ .
- for all  $q \in Q_{M'}$  and  $a \in \mathbf{alphabet} M'$ , there is at most one  $r \in Q_{M'}$  such that  $q, a \rightarrow r \in T_{M'}$ . This property holds since

## *A Simplification Algorithm*

The algorithm begins by letting the FA  $M'$  be **simplify**  $M$ , i.e., the result of running our simplification algorithm for FAs on  $M$ .  $M'$  will have the following properties:

- $M'$  is simplified.
- $M' \approx M$ .
- **alphabet**  $M' = \mathbf{alphabet}(L(M')) = \mathbf{alphabet}(L(M))$ .
- for all  $q \in Q_{M'}$  and  $a \in \mathbf{alphabet} M'$ , there is at most one  $r \in Q_{M'}$  such that  $q, a \rightarrow r \in T_{M'}$ . This property holds since  $M$  is a DFA and  $M'$  was formed by removing states and transitions from  $M$ .

## *A Simplification Algorithm*

Let  $\Sigma' = \text{alphabet } M' \cup \Sigma = \text{alphabet}(L(M)) \cup \Sigma$ . If  $M'$  is a DFA and  $\text{alphabet } M' = \Sigma'$ , the algorithm returns  $M'$  as its DFA. Otherwise, it must turn  $M'$  into a DFA whose alphabet is  $\Sigma'$ . We have that

- $\text{alphabet } M' \subseteq \Sigma'$ ; and
- for all  $q \in Q_{M'}$  and  $a \in \Sigma'$ , there is at most one  $r \in Q_{M'}$  such that  $q, a \rightarrow r \in T_{M'}$ .

Since  $M'$  is simplified, there are two cases to consider.

## *A Simplification Algorithm*

If  $M'$  has no accepting states, then  $s_{M'}$  is the only state of  $M'$  and  $M'$  has no transitions. Thus the DFA  $N$  returned by the algorithm is defined by:

- $Q_N = Q_{M'} = \{s_{M'}\}$ ;
- $s_N = s_{M'}$ ;
- $A_N = A_{M'} = \emptyset$ ; and
- $T_N = \{s_{M'}, a \rightarrow s_{M'} \mid a \in \Sigma'\}$ .



## A Simplification Algorithm

Alternatively,  $M'$  has at least one accepting state, so that  $M'$  has no dead states. Thus the DFA  $N$  returned by the algorithm is defined by:

- $Q_N = Q_{M'} \cup \{\langle \text{dead} \rangle\}$  (enough brackets are put around  $\langle \text{dead} \rangle$  so that it's not in  $Q_{M'}$ );
- $s_N = s_{M'}$ ;
- $A_N = A_{M'}$ ; and
- $T_N = T_{M'} \cup T'$ , where  $T'$  is the set of all transitions  $q, a \rightarrow \langle \text{dead} \rangle$  such that either
  - $q \in Q_{M'}$  and  $a \in \Sigma'$ , but there is no  $r \in Q_{M'}$  such that  $q, a \rightarrow r \in T_{M'}$ ; or
  - $q = \langle \text{dead} \rangle$  and  $a \in \Sigma'$ .

## *Definition of **determSimplify** Function*

We define a function **determSimplify**  $\in \text{DFA} \times \text{Alp} \rightarrow \text{DFA}$  by:  
**determSimplify**( $M, \Sigma$ ) is the result of running the above algorithm on  $M$  and  $\Sigma$ .

### **Theorem 3.11.8**

For all  $M \in \text{DFA}$  and  $\Sigma \in \text{Alp}$ :

- **determSimplify**( $M, \Sigma$ ) is deterministically simplified;
- **determSimplify**( $M, \Sigma$ )  $\approx M$ ; and
- **alphabet**(**determSimplify**( $M, \Sigma$ )) = **alphabet**( $L(M)$ )  $\cup \Sigma$ .

## Example DFA Simplification

For example, suppose  $M$  is the DFA

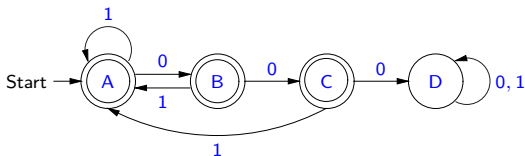

Then **determSimplify**( $M, \{2\}$ ) is the DFA

## Example DFA Simplification

For example, suppose  $M$  is the DFA

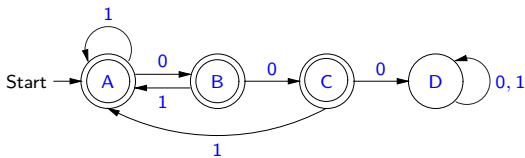

Then  $\text{determSimplify}(M, \{2\})$  is the DFA

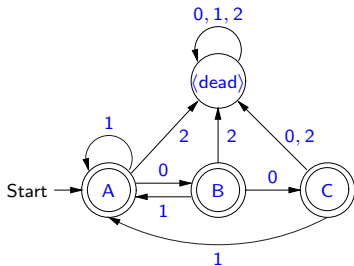

## Converting NFAs to DFAs

Suppose  $M$  is the NFA

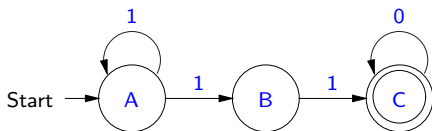

How can we convert  $M$  into a DFA?

## Converting NFAs to DFAs

Suppose  $M$  is the NFA

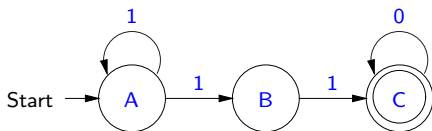

How can we convert  $M$  into a DFA?

Our approach will be to convert  $M$  into a DFA  $N$  whose states represent the elements of the set

$$\{ \Delta_M(\{A\}, w) \mid w \in \{0, 1\}^* \}.$$

For example, one of the states of  $N$  will be  $\langle A, B \rangle$ , which represents  $\{A, B\} = \Delta_M(\{A\}, 1)$ . This is the state that our DFA will be in after processing  $1$  from the start state.

## A Proposition About $\Delta$ for NFAs

### Proposition 3.11.9

Suppose  $M$  is an NFA.

- (1) For all  $P \subseteq Q_M$ ,  $\Delta_M(P, \%) = P$ .
- (2) For all  $P \subseteq Q_M$  and  $a \in \mathbf{alphabet } M$ ,  
 $\Delta_M(P, a) = \{r \in Q_M \mid p, a \rightarrow r \in T_M, \text{ for some } p \in P\}$ .
- (3) For all  $P \subseteq Q_M$  and  $x, y \in (\mathbf{alphabet } M)^*$ ,  
 $\Delta_M(P, xy) = \Delta_M(\Delta_M(P, x), y)$ .

## *Representing Finite Sets of Symbols as Symbols*

Given a finite set of symbols  $P$ , we write  $\overline{P}$  for the symbol

$$\langle a_1, \dots, a_n \rangle,$$

where  $a_1, \dots, a_n$  are all of the elements of  $P$ , in order according to our ordering on **Sym**, and without repetition. For example,  $\overline{\{B, A\}} = \langle A, B \rangle$  and  $\overline{\emptyset} = \langle \rangle$ .

It is easy to see that, if  $P$  and  $R$  are finite sets of symbols, then  $\overline{P} = \overline{R}$  iff  $P = R$ .



## *Our NFA to DFA Conversion Algorithm*

We convert an NFA  $M$  into a DFA  $N$  as follows. First, we generate the least subset  $X$  of  $\mathcal{P} Q_M$  such that:

- $\{s_M\} \in X$ ;
- for all  $P \in X$  and  $a \in \text{alphabet } M$ ,  $\Delta_M(P, a) \in X$ .

Thus  $|X| \leq 2^{|Q_M|}$ .

## Our NFA to DFA Conversion Algorithm

We convert an NFA  $M$  into a DFA  $N$  as follows. First, we generate the least subset  $X$  of  $\mathcal{P} Q_M$  such that:

- $\{s_M\} \in X$ ;
- for all  $P \in X$  and  $a \in \text{alphabet } M$ ,  $\Delta_M(P, a) \in X$ .

Thus  $|X| \leq 2^{|Q_M|}$ .

Then we define the DFA  $N$  as follows:

- $Q_N = \{\overline{P} \mid P \in X\}$ ;
- $s_N = \overline{\{s_M\}} = \langle s_M \rangle$ ;
- $A_N = \{\overline{P} \mid P \in X \text{ and } P \cap A_M \neq \emptyset\}$ ;
- $T_N = \{(\overline{P}, a, \overline{\Delta_M(P, a)}) \mid P \in X \text{ and } a \in \text{alphabet } M\}$ .

## Our NFA to DFA Conversion Algorithm

We convert an NFA  $M$  into a DFA  $N$  as follows. First, we generate the least subset  $X$  of  $\mathcal{P} Q_M$  such that:

- $\{s_M\} \in X$ ;
- for all  $P \in X$  and  $a \in \text{alphabet } M$ ,  $\Delta_M(P, a) \in X$ .

Thus  $|X| \leq 2^{|Q_M|}$ .

Then we define the DFA  $N$  as follows:

- $Q_N = \{\overline{P} \mid P \in X\}$ ;
- $s_N = \overline{\{s_M\}} = \langle s_M \rangle$ ;
- $A_N = \{\overline{P} \mid P \in X \text{ and } P \cap A_M \neq \emptyset\}$ ;
- $T_N = \{(\overline{P}, a, \overline{\Delta_M(P, a)}) \mid P \in X \text{ and } a \in \text{alphabet } M\}$ .

Then  $N$  is a DFA with alphabet  $\text{alphabet } M$  and, for all  $P \in X$  and  $a \in \text{alphabet } M$ ,  $\delta_N(\overline{P}, a) = \overline{\Delta_M(P, a)}$ .

## Conversion Example

Suppose  $M$  is the NFA

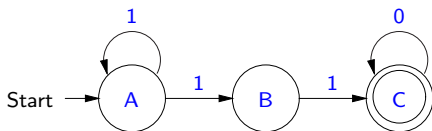

Let's work out what the DFA  $N$  is.

- To begin with,  $\{A\} \in X$ , so that  $\langle A \rangle \in Q_N$ . And  $\langle A \rangle$  is the start state of  $N$ . It is not an accepting state, since  $A \notin A_M$ .

## Conversion Example

Suppose  $M$  is the NFA

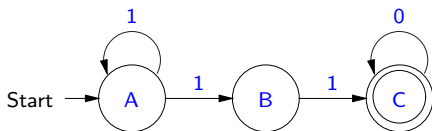

Let's work out what the DFA  $N$  is.

- To begin with,  $\{A\} \in X$ , so that  $\langle A \rangle \in Q_N$ . And  $\langle A \rangle$  is the start state of  $N$ . It is not an accepting state, since  $A \notin A_M$ .
- Since  $\{A\} \in X$ , and  $\Delta(\{A\}, 0) =$

## Conversion Example

Suppose  $M$  is the NFA

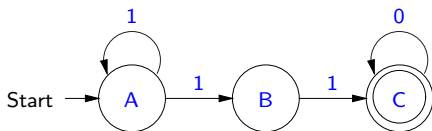

Let's work out what the DFA  $N$  is.

- To begin with,  $\{A\} \in X$ , so that  $\langle A \rangle \in Q_N$ . And  $\langle A \rangle$  is the start state of  $N$ . It is not an accepting state, since  $A \notin A_M$ .
  - Since  $\{A\} \in X$ , and  $\Delta(\{A\}, 0) = \emptyset$ , we add  $\emptyset$  to  $X$ ,  $\langle \rangle$  to  $Q_N$  and  $\langle A \rangle, 0 \rightarrow \langle \rangle$  to  $T_N$ .
- Since  $\{A\} \in X$ , and  $\Delta(\{A\}, 1) =$

## Conversion Example

Suppose  $M$  is the NFA

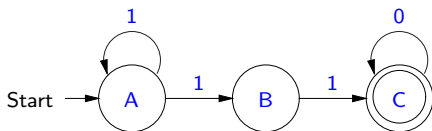

Let's work out what the DFA  $N$  is.

- To begin with,  $\{A\} \in X$ , so that  $\langle A \rangle \in Q_N$ . And  $\langle A \rangle$  is the start state of  $N$ . It is not an accepting state, since  $A \notin A_M$ .
- Since  $\{A\} \in X$ , and  $\Delta(\{A\}, 0) = \emptyset$ , we add  $\emptyset$  to  $X$ ,  $\langle \rangle$  to  $Q_N$  and  $\langle A \rangle, 0 \rightarrow \langle \rangle$  to  $T_N$ .

Since  $\{A\} \in X$ , and  $\Delta(\{A\}, 1) = \{A, B\}$ , we add  $\{A, B\}$  to  $X$ ,  $\langle A, B \rangle$  to  $Q_N$  and  $\langle A \rangle, 1 \rightarrow \langle A, B \rangle$  to  $T_N$ .

## Conversion Example

- Since  $\emptyset \in X$ ,  $\Delta(\emptyset, 0) = \emptyset$  and  $\emptyset \in X$ , we don't have to add anything to  $X$  or  $Q_N$ , but we add  $\langle \rangle, 0 \rightarrow \langle \rangle$  to  $T_N$ .  
Since  $\emptyset \in X$ ,  $\Delta(\emptyset, 1) = \emptyset$  and  $\emptyset \in X$ , we don't have to add anything to  $X$  or  $Q_N$ , but we add  $\langle \rangle, 1 \rightarrow \langle \rangle$  to  $T_N$ .



## Conversion Example

- Since  $\emptyset \in X$ ,  $\Delta(\emptyset, 0) = \emptyset$  and  $\emptyset \in X$ , we don't have to add anything to  $X$  or  $Q_N$ , but we add  $\langle \rangle, 0 \rightarrow \langle \rangle$  to  $T_N$ .  
Since  $\emptyset \in X$ ,  $\Delta(\emptyset, 1) = \emptyset$  and  $\emptyset \in X$ , we don't have to add anything to  $X$  or  $Q_N$ , but we add  $\langle \rangle, 1 \rightarrow \langle \rangle$  to  $T_N$ .
- Since  $\{A, B\} \in X$ ,  $\Delta(\{A, B\}, 0) = \emptyset$  and  $\emptyset \in X$ , we don't have to add anything to  $X$  or  $Q_N$ , but we add  $\langle A, B \rangle, 0 \rightarrow \langle \rangle$  to  $T_N$ .  
Since  $\{A, B\} \in X$ ,  $\Delta(\{A, B\}, 1) =$

## Conversion Example

- Since  $\emptyset \in X$ ,  $\Delta(\emptyset, 0) = \emptyset$  and  $\emptyset \in X$ , we don't have to add anything to  $X$  or  $Q_N$ , but we add  $\langle \rangle, 0 \rightarrow \langle \rangle$  to  $T_N$ .  
Since  $\emptyset \in X$ ,  $\Delta(\emptyset, 1) = \emptyset$  and  $\emptyset \in X$ , we don't have to add anything to  $X$  or  $Q_N$ , but we add  $\langle \rangle, 1 \rightarrow \langle \rangle$  to  $T_N$ .
- Since  $\{A, B\} \in X$ ,  $\Delta(\{A, B\}, 0) = \emptyset$  and  $\emptyset \in X$ , we don't have to add anything to  $X$  or  $Q_N$ , but we add  $\langle A, B \rangle, 0 \rightarrow \langle \rangle$  to  $T_N$ .  
Since  $\{A, B\} \in X$ ,  $\Delta(\{A, B\}, 1) = \{A, B\} \cup \{C\} = \{A, B, C\}$ , we add  $\{A, B, C\}$  to  $X$ ,  $\langle A, B, C \rangle$  to  $Q_N$ , and  $\langle A, B \rangle, 1 \rightarrow \langle A, B, C \rangle$  to  $T_N$ . Since  $\{A, B, C\}$  contains (the only) one of  $M$ 's accepting states, we add  $\langle A, B, C \rangle$  to  $A_N$ .

## Conversion Example

- Since  $\{A, B, C\} \in X$  and  $\Delta(\{A, B, C\}, 0) = \emptyset \cup \emptyset \cup \{C\} = \{C\}$ , we add  $\{C\}$  to  $X$ ,  $\langle C \rangle$  to  $Q_N$  and  $\langle A, B, C \rangle, 0 \rightarrow \langle C \rangle$  to  $T_N$ . Since  $\{C\}$  contains one of  $M$ 's accepting states, we add  $\langle C \rangle$  to  $A_N$ .

Since  $\{A, B, C\} \in X$ ,

$\Delta(\{A, B, C\}, 1) = \{A, B\} \cup \{C\} \cup \emptyset = \{A, B, C\}$  and  $\{A, B, C\} \in X$ , we don't have to add anything to  $X$  or  $Q_N$ , but we add  $\langle A, B, C \rangle, 1 \rightarrow \langle A, B, C \rangle$  to  $T_N$ .

## Conversion Example

- Since  $\{A, B, C\} \in X$  and  $\Delta(\{A, B, C\}, 0) = \emptyset \cup \emptyset \cup \{C\} = \{C\}$ , we add  $\{C\}$  to  $X$ ,  $\langle C \rangle$  to  $Q_N$  and  $\langle A, B, C \rangle, 0 \rightarrow \langle C \rangle$  to  $T_N$ . Since  $\{C\}$  contains one of  $M$ 's accepting states, we add  $\langle C \rangle$  to  $A_N$ .

Since  $\{A, B, C\} \in X$ ,  $\Delta(\{A, B, C\}, 1) = \{A, B\} \cup \{C\} \cup \emptyset = \{A, B, C\}$  and  $\{A, B, C\} \in X$ , we don't have to add anything to  $X$  or  $Q_N$ , but we add  $\langle A, B, C \rangle, 1 \rightarrow \langle A, B, C \rangle$  to  $T_N$ .

- Since  $\{C\} \in X$ ,  $\Delta(\{C\}, 0) = \{C\}$  and  $\{C\} \in X$ , we don't have to add anything to  $X$  or  $Q_N$ , but we add  $\langle C \rangle, 0 \rightarrow \langle C \rangle$  to  $T_N$ . Since  $\{C\} \in X$ ,  $\Delta(\{C\}, 1) = \emptyset$  and  $\emptyset \in X$ , we don't have to add anything to  $X$  or  $Q_N$ , but we add  $\langle C \rangle, 1 \rightarrow \langle \rangle$  to  $T_N$ .

## Conversion Example

Since there are no more elements to add to  $X$ , we are done. Thus, the DFA  $N$  is

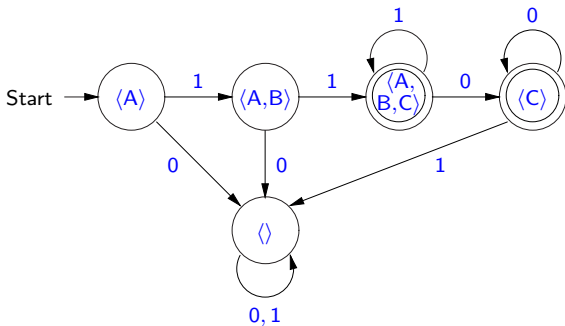

## Correctness of Conversion Algorithm

### Lemma 3.11.10

For all  $w \in (\text{alphabet } M)^*$ :

- $\Delta_M(\{s_M\}, w) \in X$ ; and
- $\delta_N(s_N, w) = \overline{\Delta_M(\{s_M\}, w)}$ .

**Proof.** By left string induction.

(Basis Step) We have that  $\Delta_M(\{s_M\}, \%) = \{s_M\} \in X$  and  $\delta_N(s_N, \%) = \quad = \quad = \quad \cdot$ .

## Correctness of Conversion Algorithm

### Lemma 3.11.10

For all  $w \in (\text{alphabet } M)^*$ :

- $\Delta_M(\{s_M\}, w) \in X$ ; and
- $\delta_N(s_N, w) = \overline{\Delta_M(\{s_M\}, w)}$ .

**Proof.** By left string induction.

(Basis Step) We have that  $\Delta_M(\{s_M\}, \%) = \{s_M\} \in X$  and  $\delta_N(s_N, \%) = s_N = \overline{\Delta_M(\{s_M\}, \%)}$ .

## Correctness of Conversion Algorithm

### Lemma 3.11.10

For all  $w \in (\text{alphabet } M)^*$ :

- $\Delta_M(\{s_M\}, w) \in X$ ; and
- $\delta_N(s_N, w) = \overline{\Delta_M(\{s_M\}, w)}$ .

**Proof.** By left string induction.

(Basis Step) We have that  $\Delta_M(\{s_M\}, \%) = \{s_M\} \in X$  and  $\delta_N(s_N, \%) = s_N = \overline{\{s_M\}} =$  .



## Correctness of Conversion Algorithm

### Lemma 3.11.10

For all  $w \in (\text{alphabet } M)^*$ :

- $\Delta_M(\{s_M\}, w) \in X$ ; and
- $\delta_N(s_N, w) = \overline{\Delta_M(\{s_M\}, w)}$ .

**Proof.** By left string induction.

(Basis Step) We have that  $\Delta_M(\{s_M\}, \%) = \{s_M\} \in X$  and  $\delta_N(s_N, \%) = s_N = \overline{\{s_M\}} = \overline{\Delta_M(\{s_M\}, \%)}$ .

## Correctness

**Proof (cont.).** (Inductive Step) Suppose  $a \in \text{alphabet } M$  and  $w \in (\text{alphabet } M)^*$ . Assume the inductive hypothesis:

$$\Delta_M(\{s_M\}, w) \in X \text{ and } \delta_N(s_N, w) = \overline{\Delta_M(\{s_M\}, w)}.$$

Since  $\Delta_M(\{s_M\}, w) \in X$  and  $a \in \text{alphabet } M$ , we have that  $\Delta_M(\{s_M\}, wa) = \Delta_M(\Delta_M(\{s_M\}, w), a) \in X$ . Thus

$$\begin{aligned} \delta_N(s_N, wa) &= \\ &= \\ &= \\ &= \end{aligned}$$

□

## Correctness

**Proof (cont.).** (Inductive Step) Suppose  $a \in \text{alphabet } M$  and  $w \in (\text{alphabet } M)^*$ . Assume the inductive hypothesis:

$$\Delta_M(\{s_M\}, w) \in X \text{ and } \delta_N(s_N, w) = \overline{\Delta_M(\{s_M\}, w)}.$$

Since  $\Delta_M(\{s_M\}, w) \in X$  and  $a \in \text{alphabet } M$ , we have that  $\Delta_M(\{s_M\}, wa) = \Delta_M(\Delta_M(\{s_M\}, w), a) \in X$ . Thus

$$\delta_N(s_N, wa) = \delta_N(\delta_N(s_N, w), a)$$

=

=

=

□

## Correctness

**Proof (cont.).** (Inductive Step) Suppose  $a \in \text{alphabet } M$  and  $w \in (\text{alphabet } M)^*$ . Assume the inductive hypothesis:

$$\Delta_M(\{s_M\}, w) \in X \text{ and } \delta_N(s_N, w) = \overline{\Delta_M(\{s_M\}, w)}.$$

Since  $\Delta_M(\{s_M\}, w) \in X$  and  $a \in \text{alphabet } M$ , we have that  $\Delta_M(\{s_M\}, wa) = \Delta_M(\Delta_M(\{s_M\}, w), a) \in X$ . Thus

$$\begin{aligned} \delta_N(s_N, wa) &= \delta_N(\delta_N(s_N, w), a) \\ &= \delta_N(\overline{\Delta_M(\{s_M\}, w)}, a) && \text{(ind. hyp.)} \\ &= \\ &= \end{aligned}$$

□

## Correctness

**Proof (cont.).** (Inductive Step) Suppose  $a \in \mathbf{alphabet } M$  and  $w \in (\mathbf{alphabet } M)^*$ . Assume the inductive hypothesis:

$$\Delta_M(\{s_M\}, w) \in X \text{ and } \delta_N(s_N, w) = \overline{\Delta_M(\{s_M\}, w)}.$$

Since  $\Delta_M(\{s_M\}, w) \in X$  and  $a \in \mathbf{alphabet } M$ , we have that  $\Delta_M(\{s_M\}, wa) = \Delta_M(\Delta_M(\{s_M\}, w), a) \in X$ . Thus

$$\begin{aligned} \delta_N(s_N, wa) &= \delta_N(\delta_N(s_N, w), a) \\ &= \delta_N(\overline{\Delta_M(\{s_M\}, w)}, a) && \text{(ind. hyp.)} \\ &= \overline{\Delta_M(\Delta_M(\{s_M\}, w), a)} \\ &= \end{aligned}$$

□

## Correctness

**Proof (cont.).** (Inductive Step) Suppose  $a \in \mathbf{alphabet } M$  and  $w \in (\mathbf{alphabet } M)^*$ . Assume the inductive hypothesis:

$\Delta_M(\{s_M\}, w) \in X$  and  $\delta_N(s_N, w) = \overline{\Delta_M(\{s_M\}, w)}$ .

Since  $\Delta_M(\{s_M\}, w) \in X$  and  $a \in \mathbf{alphabet } M$ , we have that  $\Delta_M(\{s_M\}, wa) = \Delta_M(\Delta_M(\{s_M\}, w), a) \in X$ . Thus

$$\begin{aligned}\delta_N(s_N, wa) &= \delta_N(\delta_N(s_N, w), a) \\ &= \delta_N(\overline{\Delta_M(\{s_M\}, w)}, a) && \text{(ind. hyp.)} \\ &= \overline{\Delta_M(\Delta_M(\{s_M\}, w), a)} \\ &= \overline{\Delta_M(\{s_M\}, wa)}.\end{aligned}$$

□

## Correctness

### Lemma 3.11.11

$$L(N) = L(M).$$

**Proof.** ( $L(M) \subseteq L(N)$ ) Suppose  $w \in L(M)$ , so that  $w \in (\text{alphabet } M)^* = (\text{alphabet } N)^*$  and  $\Delta_M(\{s_M\}, w) \cap A_M \neq \emptyset$ . By Lemma 3.11.10, we have that  $\Delta_M(\{s_M\}, w) \in X$  and  $\delta_N(s_N, w) = \overline{\Delta_M(\{s_M\}, w)}$ . Since  $\Delta_M(\{s_M\}, w) \in X$  and  $\Delta_M(\{s_M\}, w) \cap A_M \neq \emptyset$ , it follows that  $\delta_N(s_N, w) = \overline{\Delta_M(\{s_M\}, w)} \in A_N$ . Thus  $w \in L(N)$ .

□

## Correctness

### Lemma 3.11.11

$$L(N) = L(M).$$

**Proof.** ( $L(M) \subseteq L(N)$ ) Suppose  $w \in L(M)$ , so that  $w \in (\text{alphabet } M)^* = (\text{alphabet } N)^*$  and  $\Delta_M(\{s_M\}, w) \cap A_M \neq \emptyset$ . By Lemma 3.11.10, we have that  $\Delta_M(\{s_M\}, w) \in X$  and  $\delta_N(s_N, w) = \overline{\Delta_M(\{s_M\}, w)}$ . Since  $\Delta_M(\{s_M\}, w) \in X$  and  $\Delta_M(\{s_M\}, w) \cap A_M \neq \emptyset$ , it follows that  $\delta_N(s_N, w) = \overline{\Delta_M(\{s_M\}, w)} \in A_N$ . Thus  $w \in L(N)$ .

( $L(N) \subseteq L(M)$ ) Suppose  $w \in L(N)$ , so that  $w \in (\text{alphabet } N)^* = (\text{alphabet } M)^*$  and  $\delta_N(s_N, w) \in A_N$ . By Lemma 3.11.10, we have that  $\delta_N(s_N, w) = \overline{\Delta_M(\{s_M\}, w)}$ . Thus  $\overline{\Delta_M(\{s_M\}, w)} \in A_N$ , so that  $\Delta_M(\{s_M\}, w) \cap A_M \neq \emptyset$ . Thus  $w \in L(M)$ .  $\square$



## Conversion Function

We define a function  $\mathbf{nfaToDFA} \in \mathbf{NFA} \rightarrow \mathbf{DFA}$  by:  $\mathbf{nfaToDFA} M$  is the result of running the preceding algorithm with input  $M$ .

### Theorem 3.11.12

For all  $M \in \mathbf{NFA}$ :

- $\mathbf{nfaToDFA} M \approx M$ ; and
- $\mathbf{alphabet}(\mathbf{nfaToDFA} M) = \mathbf{alphabet} M$ .

## *Processing DFAs in Forlan*

The Forlan module `DFA` defines an abstract type `dfa` (in the top-level environment) of deterministic finite automata, along with various functions for processing DFAs.

Values of type `dfa` are implemented as values of type `fa`, and the module `DFA` provides the following injection and projection functions

```
val injToFA      : dfa -> fa
val injToEFA     : dfa -> efa
val injToNFA     : dfa -> nfa
val projFromFA   : fa -> dfa
val projFromEFA  : efa -> dfa
val projFromNFA  : nfa -> dfa
```

These functions are available in the top-level environment with the names `injDFAToFA`, `injDFAToEFA`, `injDFAToNFA`, `projFAToDFA`, `projEFAToDFA` and `projNFAToDFA`.

## *Processing DFAs in Forlan*

The module `DFA` also defines the functions:

```
val input          : string -> dfa
val determProcStr  : dfa -> sym * str -> sym
val determAccepted : dfa -> str -> bool
val determSimplified : dfa -> bool
val determSimplify : dfa * sym set -> dfa
val fromNFA       : nfa -> dfa
```

The last of these functions is available in the top-level environment as:

```
val nfaToDFA : nfa -> dfa
```

## *Processing DFAs in Forlan*

Most of the functions for processing FAs that were introduced in previous sections are inherited by **DFA**:

```
val output                : string * dfa -> unit
val numStates             : dfa -> int
val numTransitions       : dfa -> int
val alphabet              : dfa -> sym set
val equal                  : dfa * dfa -> bool
val checkLP                : dfa -> lp -> unit
val validLP                : dfa -> lp -> bool
val isomorphism            : dfa * dfa * sym_rel -> bool
val findIsomorphism        : dfa * dfa -> sym_rel
val isomorphic             : dfa * dfa -> bool
val renameStates           : dfa * sym_rel -> dfa
val renameStatesCanonically : dfa -> dfa
```

## *Processing DFAs in Forlan*

More inherited functions:

```
val processStr      : dfa -> sym set * str -> sym set
val accepted       : dfa -> str -> bool
val findLP         : dfa -> sym set * str * sym set -> lp
val findAcceptingLP : dfa -> str -> lp
```

## Forlan Examples

Suppose `dfa` is the `dfa`

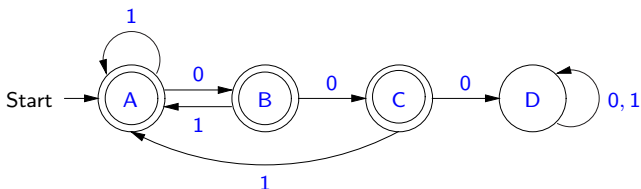

We can turn `dfa` into an equivalent deterministically simplified DFA whose alphabet is the union of the alphabet of the language of `dfa` and  $\{2\}$ , i.e., whose alphabet is  $\{0,1,2\}$ , as follows.

```
- val dfa' = DFA.determSimplify(dfa, SymSet.input "");
@ 2
@ .
val dfa' = - : dfa
```

## *Forlan Examples*

```
- DFA.output("", dfa');  
{states} A, B, C, <dead> {start state} A  
{accepting states} A, B, C  
{transitions}  
A, 0 -> B; A, 1 -> A; A, 2 -> <dead>; B, 0 -> C;  
B, 1 -> A; B, 2 -> <dead>; C, 0 -> <dead>; C, 1 -> A;  
C, 2 -> <dead>; <dead>, 0 -> <dead>;  
<dead>, 1 -> <dead>; <dead>, 2 -> <dead>  
val it = () : unit
```

## Forlan Examples

Thus dfa' is

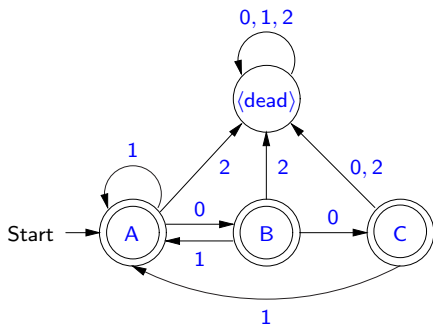



## Forlan Examples

Suppose that `nfa` is the `nfa`

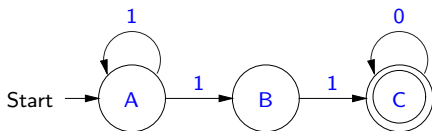

We can convert `nfa` to a DFA as follows:

```
- val dfa = nfaToDFA nfa;  
val dfa = - : dfa
```

## Forlan Examples

```
- DFA.output("", dfa);  
{states} <>, <A>, <C>, <A,B>, <A,B,C>  
{start state} <A> {accepting states} <C>, <A,B,C>  
{transitions}  
<>, 0 -> <>; <>, 1 -> <>; <A>, 0 -> <>;  
<A>, 1 -> <A,B>; <C>, 0 -> <C>; <C>, 1 -> <>;  
<A,B>, 0 -> <>; <A,B>, 1 -> <A,B,C>;  
<A,B,C>, 0 -> <C>; <A,B,C>, 1 -> <A,B,C>  
val it = () : unit
```

## Forlan Examples

Thus dfa is

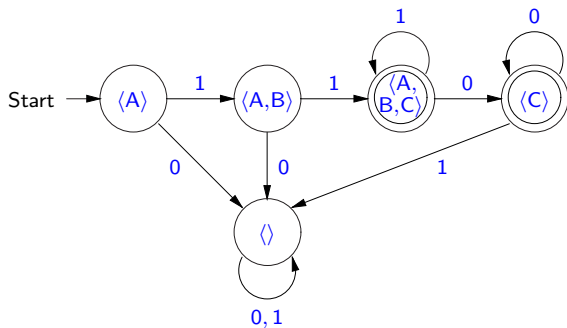

## Forlan Examples

Finally, we see an example in which an NFA with 4 states is converted to a DFA with  $2^4 = 16$  states.

Suppose `nfa'` is the NFA

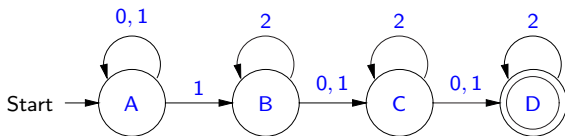

## Forlan Examples

Finally, we see an example in which an NFA with 4 states is converted to a DFA with  $2^4 = 16$  states.

Suppose `nfa'` is the NFA

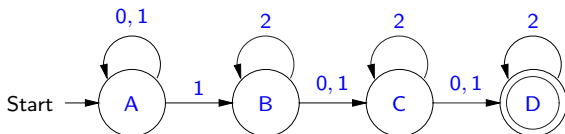

We can convert `nfa'` into a DFA, as follows:

```
- val dfa' = nfaToDFA nfa';
val dfa' = - : dfa
- DFA.numStates dfa';
val it = 16 : int
```

In Section 3.13, we will use Forlan to show that there is no DFA with fewer than 16 states that accepts the language accepted by `nfa'` and `dfa'`.